

SECTION H

Table of Contents



Single Pole Inlines and Receptacles



Spider® II Temporary Power Boxes



Temporary Lighting and Maintenance Worklights



Single Pole Devices	Page	Temporary Power	Page
Series 15 - 150 Amp, 600 Volts		Spider® II Temporary Power Boxes	
Features and Benefits	H-2	Features and Benefits	H-11
Inlines, Receptacles, Protective Caps and Weather Protective Covers	H-3	50A and 60A Spider® II Boxes	H-12
Tees, Gender Reversing Devices, Replacement Bodies and Accessories	H-4	Cable Sets, Receptacles and Replacement Parts	H-13
Specifications and Dimensions	H-5	Temporary Power Boxes and Power Cables	H-14
Series 16 - 300 and 400 Amp, 600 Volts		Heavy-Duty Portable Outlet Boxes and Cover Plates	H-15
Features and Benefits	H-2	Temporary Lighting	
Inlines and Receptacles	H-6	Construction Site Lighting	H-16
Receptacles, Terminals, Protective Caps and Weather Protective Covers	H-7	Maintenance Worklights, Accessories and Replacement Items	H-17
Tees, 3-Fers, Gender Reversing Devices, and Distribution Block	H-8	Explosion Proof/Confined Space Lighting	H-17
Replacement Parts, Snap Back Covers and Accessories	H-8	Pre-Wired Portable Outlet Boxes, Worklights and Accessories	H-18
Specifications and Dimensions	H-9		
Series 18 - 300 and 400 Amp, 600V AC/250V DC			
Features, 300 and 400 Amp Inlines	H-10		
Replacement Bodies and Accessories	H-10		
Specifications and Dimensions	H-10		

Single Pole Devices and Temporary Power

Features and Benefits

Series 15 and 16 - 150, 300 and 400 Amp, 600 Volts

Hubbell Wiring Device-Kellems offers a full line of innovative, high quality, Series 15 and Series 16 single pole inlines, receptacles and accessories for the most demanding environments.

Single pole devices are the right choice for supplying temporary electrical power distribution for entertainment, theme parks, carnival equipment, concerts, movie making and numerous other applications requiring temporary power.

Single pole devices have been designed with ease of assembly and disassembly in mind, no special tools are required. A high strength non-conductive retaining screw is all that is needed to securely lock the contacts to the insulated sleeve.

UL Enclosure Types 3R, 4X and 12 Rating suitable for use in almost any environment.



HBL15MBK



HBL15FBK



Housing Design

- Insulgrip® style housing for superior gripping, conforms to the user's hand making it easy to connect and disconnect, even with gloves on
- Easily identifiable cable, cut off points for secure fit allows you to easily customize and cut the housing to the required/correct cable size
- Accommodates wide range of cables



Contacts

- Provides high contact pressure and vibration resistant connection, which helps reduce operating temperatures and extends product life
- High conductivity brass contact provides improved performance by helping to reduce operating temperatures and extends life



Safety

- Rounded corners reduce the possibility of catching or snagging on structures or equipment
- Non-conductive retaining screw locks contacts in place and allows for easy installation; prevents contact movement within housing
- Recessed mounting screw minimizes screwdriver slippage



Assembly

- Special screw thread requires fewer turns than most competitors and reduces the risk of a conductive screw being substituted
- Extra long non-conductive inner sleeve reduces force required to install housing over contacts; easier to rotate contact in body for installing retaining screw



Identification

- Lock symbol aids in the mating of devices and provides a clear indication that the devices are properly connected
- With lock indicator symbol making mating clear and simple; devices can lock 180° to prevent unintended disconnects



Installation

- Engineered body design makes installation simple with no need for additional tools and the non-metallic retaining screw helps to make operation safe for all involved
- Strip gauge molded into every inline and receptacle housing; simplifies installation and saves time

Series 15 - 150 Amp, 600 Volts

Enclosure Types
3R, 4X, 12



150 Amp Inlines

Description	Color	Male Inline
150 amp, thermoplastic elastomer, cable size #8 - #2 AWG.	Black	HBL15MBK
	White	HBL15MW
	Green	HBL15MGN
	Red	HBL15MR
	Blue	HBL15MBL
	Brown	HBL15MBN
	Orange	HBL15MO
	Yellow	HBL15MY
	Gray	HBL15MGY



150 Amp Inlines

Description	Color	Female Inline
150 amp, thermoplastic elastomer, cable size #8 - #2 AWG.	Black	HBL15FBK
	White	HBL15FW
	Green	HBL15FGN
	Red	HBL15FR
	Blue	HBL15FBL
	Brown	HBL15FBN
	Orange	HBL15FO
	Yellow	HBL15FY
	Gray	HBL15FGY

Receptacles, Stud Type Through Hole Mounting



Description	Color	Male Receptacles	Female Receptacles
150 amp, Panel Mount, thermoplastic, cable size #8 - #2 AWG.	Black	HBL15MRSBK	HBL15FRSBK
	White	HBL15MRSW	HBL15FRSW
	Green	HBL15MRSGN	HBL15FRSGN
	Red	HBL15MRSR	HBL15FRSR
	Blue	HBL15MRSBL	HBL15FRSBL
	Brown	HBL15MRSBN	HBL15FRSBN
	Orange	HBL15MRSO	HBL15FRSO
	Yellow	HBL15MRSY	HBL15FRSY
	Gray*	—	—

Receptacles, Double Set Screw Through Hole Mounting



Description	Color	Male Receptacles	Female Receptacles
150 amp, Panel Mount, thermoplastic, cable size #8 - #2 AWG.	Black	HBL15MRBK	HBL15FRBK
	White	HBL15MRW	HBL15FRW
	Green	HBL15MRGN	HBL15FRGN
	Red	HBL15MRR	HBL15FRR
	Blue	HBL15MRBL	HBL15FRBL
	Brown	HBL15MRBN	HBL15FRBN
	Orange	HBL15MRO	HBL15FRO
	Yellow	HBL15MRY	HBL15FRY
	Gray	HBL15MRGY	HBL15FRGY

Note: *Gray is available upon request. Contact factory.



Protective Caps

Description	Color	Fits Male Devices	Fits Female Devices
Fits 150 amp inlines and receptacles.	Black	HBL15MCAPBK	HBL15FCAPBK
	White	HBL15MCAPW	HBL15FCAPW
	Green	HBL15MCAPGN	HBL15FCAPGN
	Red	HBL15MCAPR	HBL15FCAPR
	Blue	HBL15MCAPBL	HBL15FCAPBL
	**	—	—

Note: **Additional colors are available upon request. Contact factory.

Weather Protective Covers



Description	Color	Catalog Number
Use with stud type or double set screw receptacles.	Clear	HBL15NCC
	Black	HBL15NCBK
	White	HBL15NCW
	Green	HBL15NCGN
	Red	HBL15NCR
	Blue	HBL15NCBL
	Brown	HBL15NCBN
	Orange	HBL15NCO
	Yellow	HBL15NCY

Series 15 - 150 Amp, 600 Volts

Enclosure Types
3R, 4X, 12

Tees



Color	Paralleling Tee (Male-Male-Female)	Tapping Tee (Female-Male-Female)
Black	HBL15PTBK	HBL15TBK
White	HBL15PTW	HBL15TWT
Green	HBL15PTGN	HBL15TGN
Red	HBL15PTR	HBL15TR
Blue	HBL15PTBL	HBL15TBL

Gender Reversing Devices



Color	Double Male (Male-Male)	Double Female (Female-Female)
Black	HBL15DMBK*	HBL15DFBK*
White	HBL15DMW	HBL15DFW
Green	HBL15DMGN	HBL15DFGN
Red	HBL15DMR*	HBL15DFR*
Blue	HBL15DMBL*	HBL15DFBL*

Note: *UL 1691 restricts the use of male-to-male or female-to-female devices to Grounding (Green) or Neutral (White) conductors. Consult factory for availability of other non UL listed colors.

Replacement Bodies (25 Pack)



Color	Male Body	Female Body
Black	HBL15MBBK	HBL15FBBK
White	HBL15MBW	HBL15FBW
Green	HBL15MBGN	HBL15FBGN
Red	HBL15MBR	HBL15FBR
Blue	HBL15MBBL	HBL15FBL

Note: **Additional colors are available upon request. Contact factory.

Replacement Contacts (25 Pack)



Description	Male Pin	Female Sleeve
Contact, 150 amp	HBL15RCM	HBL15RCF

Accessories

Description	Catalog Number
Accessory Kit, retaining screw, copper foil, terminal screws and brass wire.	HBL15PK
Replacement retaining screw (100 pack).	HBL15RS
Copper foil (100 pack).	HBL15CF
Brass wire (100 pack).	HBL15BW
Terminal screw - inline (100 pack).	HBL15TS25
Terminal screw - panel mount (100 pack).	HBL15TS375
Ferrule #2 AWG (100 pack).	HBL15F2
Ferrule #4 AWG (100 pack).	HBL15F4



HBL15PK



HBL15RS



HBL15CF



HBL15BW



HBL15TS25



HBL15TS375



HBL15F2
HBL15F4

Single Pole Devices and Temporary Power

Series 15 - 150 Amp, 600 Volts

Specifications

Electrical	
Voltage Ratings	600V Maximum
Amperage Rating	150A Maximum
Mechanical	
Terminal Accommodation	Inline: #8 AWG to #2 AWG Receptacle: #8 AWG to #2 AWG
Product ID	Ratings are a permanent part of device
Base Compound	Inline: Thermoplastic Elastomer (TPE) Receptacle: Polybutylene Terephthalate (PBT)
Contact Material	Brass
Retaining Screw Material	Nylon

Certification / Environmental

UL and cUL Listed
 UL Enclosure Types 3R, 4X, 12
 UL1691 standard for single pole locking-type separable connectors
 National Electric Code (NEC®), ANSI/NFPA 70
 Flammability: HB per UL94 or CSA 22.2. 0.17

Conductor Ampacity Chart (Type SC/PPC Wire)

Cable Size	Ampacity*
#8	80
#6	105
#4	140
#2	190

Note: *90°C column NEC Table 400.5(A)(2).

Dimensions

Inlines

	A	B	C	D
Male	4.54" (115.3)	1.04" (26.4)	.86" (21.8)	3.22" (81.7)
Female	4.60" (116.8)	1.11" (28.2)	.68" (17.3)	3.28" (83.2)

Weatherproof Cover

	A	B	C
Series 15	2.03" (51.5)	1.14" (29.0)	1.49" (37.9)

Panel Mount Receptacles

Threaded Stud	A	B	C	D	E	F	Mounting Hole	Termination
Male	1.86" (47.2)	1.37" (34.8)	2.82" (71.6)	.86" (22.0)	.80" (20.4)	1.20" (30.5)	Through 3x Ø .20"	5/16-18 Threaded Stud
Female	1.86" (47.2)	1.37" (34.8)	2.88" (73.1)	.86" (22.0)	.80" (20.4)	1.26" (32.0)	Through 3x Ø .20"	5/16-18 Threaded Stud
Double Set Screw	A	B	C	D	E	F	Mounting Hole	Termination
Male	1.86" (47.2)	1.37" (34.8)	2.90" (73.6)	.86" (22.0)	.88" (22.2)	1.20" (30.5)	Through 3x Ø .20"	(2) 5/32 Socket Head Set Screws
Female	1.86" (47.2)	1.37" (34.8)	2.95" (74.9)	.86" (22.0)	.87" (22.2)	1.26" (32.0)	Through 3x Ø .20"	(2) 5/32 Socket Head Set Screws

Tees

	A	B	C
Tapping Tee	2.67" (67.9)	4.28" (108.7)	.865" (21.9)
Paralleling Tee	2.67" (67.9)	4.22" (107.2)	.865" (21.9)

Gender Reversing Devices

	A	B	C
Double Male	4.22" (107.2)	.86" (21.8)	—
Double Female	4.22" (107.2)	1.05" (26.7)	.68" (17.3)

Tapping Tee

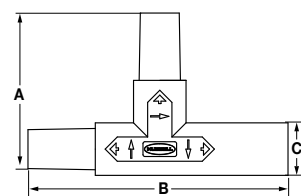

Paralleling Tee

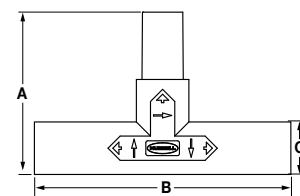

Gender Reversing - Double Male

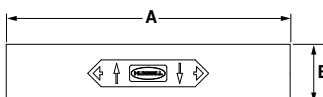

Gender Reversing - Double Female

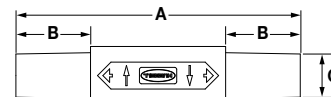

Male Inline

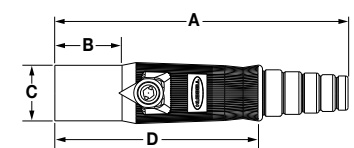

Female Inline

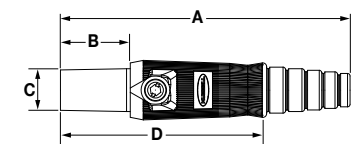

Weatherproof Cover

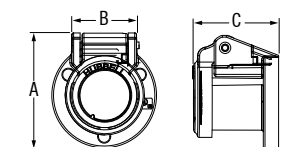

Threaded Stud (Male Shown)

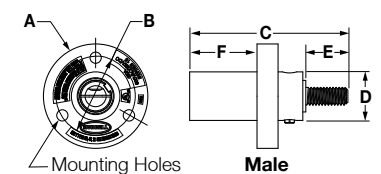

Double Set Screw (Male Shown)

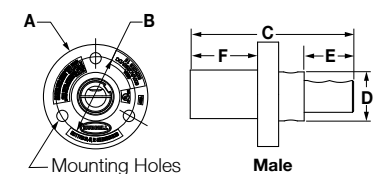

Series 16 - 300 and 400 Amp, 600 Volts

Enclosure Types
3R, 4X, 12



300 Amp Inlines

Description	Color	Male Inline	Female Inline
300 amp, thermoplastic elastomer, cable size #6 - 2/0 AWG.	Black	HBL300MBK	HBL300FBK
	White	HBL300MW	HBL300FW
	Green	HBL300MGN	HBL300FGN
	Red	HBL300MR	HBL300FR
	Blue	HBL300MBL	HBL300FBL
	Brown	HBL300MBN	HBL300FBN
	Orange	HBL300MO	HBL300FO
	Yellow	HBL300MY	HBL300FY
	Gray*	—	—

Note: *Gray is available upon request. Contact factory.



400 Amp Inlines

Description	Color	Male Inline	Female Inline
400 amp, thermoplastic elastomer, cable size 2/0 - 4/0 AWG.	Black	HBL400MBK	HBL400FBK
	White	HBL400MW	HBL400FW
	Green	HBL400MGN	HBL400FGN
	Red	HBL400MR	HBL400FR
	Blue	HBL400MBL	HBL400FBL
	Brown	HBL400MBN	HBL400FBN
	Orange	HBL400MO	HBL400FO
	Yellow	HBL400MY	HBL400FY
Gray	HBL400MGY	HBL400FGY	

Receptacles, Double Set Screw Through Hole Mounting



Description	Color	Male Receptacles	Female Receptacles
400 amp, Panel Mount, thermoplastic elastomer, cable size #4 - 4/0 AWG, mates with 300 and 400 amp Inlines.	Black	HBLMRBK	HBLFRBK
	White	HBLMRW	HBLFRW
	Green	HBLMRGN	HBLFRGN
	Red	HBLMRR	HBLFRR
	Blue	HBLMRBL	HBLFRBL
	Brown	HBLMRBN	HBLFRBN
	Orange	HBLMRO	HBLFRO
	Yellow	HBLMRY	HBLFRY
	Gray	HBLMRGY	HBLFRGY

Angled Receptacles, Double Set Screw Through Hole Mounting



Description	Color	Male Receptacles	Female Receptacles
400 amp, Panel Mount, thermoplastic elastomer, cable size #4 - 4/0 AWG, mates with 300 and 400 amp Inlines.	Black	HBLMRABK	HBLFRABK
	White	HBLMRAW	HBLFRAW
	Green	HBLMRAGN	HBLFRAGN
	Red	HBLMRAR	HBLFRAR
	Blue	HBLMRABL	HBLFRABL
	Brown	HBLMRABN	HBLFRABN
	Orange	HBLMRAO	HBLFRAO
	Yellow	HBLMRAY	HBLFRAY
	Gray*	—	—

Note: *Gray is available upon request. Contact factory.

Receptacles, Stud Type Threaded Hole Mounting



Description	Color	Male Receptacles	Female Receptacles
400 amp Panel Mount, thermoplastic elastomer, mates with 300 and 400 amp Inlines.	Black	HBLMRSBK	HBLFRSBK
	White	HBLMRSW	HBLFRSW
	Green	HBLMRSGN	HBLFRSGN
	Red	HBLMRSCR	HBLFRSCR
	Blue	HBLMRSCL	HBLFRSCL
	Brown	HBLMRSBCL	HBLFRSCL
	Orange	HBLMRSO	HBLFRSO
	Yellow	HBLMRSY	HBLFRSY

Receptacles, Extended Stud Type Threaded Hole Mounting



Description	Color	Male Receptacles	Female Receptacles
400 amp Panel Mount, thermoplastic elastomer, mates with 300 and 400 amp Inlines.	Black	HBLMRSCEBK	HBLFRSCEBK
	White	HBLMRSCEW	HBLFRSCEW
	Green	HBLMRSCEGN	HBLFRSCEGN
	Red	HBLMRSCEER	HBLFRSCEER
	Blue	HBLMRSCEBL	HBLFRSCEBL
	Brown	HBLMRSCEBN	HBLFRSCEBN
	Orange	HBLMRSCEO	HBLFRSCEO
	Yellow	HBLMRSCEY	HBLFRSCEY

Receptacles, Stud Type Through Hole Mounting



Description	Color	Male Receptacles	Female Receptacles
400 amp Panel Mount, thermoplastic elastomer, mates with 300 and 400 amp Inlines.	Black	HBLMRSBK	HBLFRSBK
	White	HBLMRSW	HBLFRSW
	Green	HBLMRSGN	HBLFRSGN
	Red	HBLMRSR	HBLFRSR
	Blue	HBLMRSBL	HBLFRSBL
	Brown	HBLMRSBN	HBLFRSBN
	Orange	HBLMRSO	HBLFRSO
	Yellow	HBLMRSY	HBLFRSY

Angled Receptacles, Stud Type Through Hole Mounting



Description	Color	Male Receptacles	Female Receptacles
400 amp Panel Mount, thermoplastic elastomer, mates with 300 and 400 amp Inlines.	Black	HBLMRASBK	HBLFRASBK
	White	HBLMRASW	HBLFRASW
	Green	HBLMRASGN	HBLFRASGN
	Red	HBLMRASR	HBLFRASR
	Blue	HBLMRASBL	HBLFRASBL
	Brown	HBLMRASBN	HBLFRASBN
	Orange	HBLMRASO	HBLFRASO
	Yellow	HBLMRASY	HBLFRASY

Series 16 - 300 and 400 Amp, 600 Volts

Enclosure Types
3R, 4X, 12

Receptacles, Bus Bar Threaded Hole Mounting



Description	Color	Male Receptacles	Female Receptacles
400 amp Panel Mount, thermoplastic elastomer, mates with 300 and 400 amp Inlines.	Black	HBLMRBBK	HBLFRBBK
	White	HBLMRBW	HBLFRBW
	Green	HBLMRBGN	HBLFRBGN
	Red	HBLMRBR	HBLFRBR
	Blue	HBLMRBBL	HBLFRBBL
	Brown	HBLMRBBN	HBLFRBBN
	Orange	HBLMRBO	HBLFRBO
	Yellow	HBLMRBY	HBLFRBY

Angled Receptacles, Bus Bar Through Hole Mounting



Description	Color	Male Receptacles	Female Receptacles
400 amp Panel Mount, thermoplastic elastomer, mates with 300 and 400 amp Inlines.	Black	HBLMRABBK	HBLFRABBK
	White	HBLMRABW	HBLFRABW
	Green	HBLMRABGN	HBLFRABGN
	Red	HBLMRABR	HBLFRABR
	Blue	HBLMRABBL	HBLFRABBL
	Brown	HBLMRABBN	HBLFRABBN
	Orange	HBLMRABO	HBLFRABO
	Yellow	HBLMRABY	HBLFRABY

Receptacles, Bus Bar, 2 Holes Threaded Hole Mounting



Description	Color	Male Receptacles	Female Receptacles
400 amp Panel Mount, thermoplastic elastomer, mates with 300 and 400 amp Inlines.	Black	HBLMRB2BK	HBLFRB2BK
	White	HBLMRB2W	HBLFRB2W
	Green	HBLMRB2GN	HBLFRB2GN
	Red	HBLMRB2R	HBLFRB2R
	Blue	HBLMRB2BL	HBLFRB2BL
	Brown	HBLMRB2BN	HBLFRB2BN
	Orange	HBLMRB2O	HBLFRB2O
	Yellow	HBLMRB2Y	HBLFRB2Y

Terminals, Offset Straight Style



Description	Color	Male Receptacles	Female Receptacles
400 amp Terminal, thermoplastic elastomer, mates with 300 and 400 amp Inlines.	Black	HBLMOSBK	HBLFOSBK
	White	HBLMOSW	HBLFOSW
	Green	HBLMOSGN	HBLFOSGN
	Red	HBLMOSR	HBLFOSR
	Blue	HBLMOSBL	HBLFOSBL
	Brown	HBLMOSBN	HBLFOSBN
	Orange	HBLMOSO	HBLFOSO
	Yellow	HBLMOSY	HBLFOSY

Note: Terminals are UL Type 1 only.

Angled Terminals, Offset Straight Style



Description	Color	Male Receptacles	Female Receptacles
400 amp Terminal, thermoplastic elastomer, mates with 300 and 400 amp Inlines.	Black	HBLMOABK	HBLFOABK
	White	HBLMOAW	HBLFOAW
	Green	HBLMOAGN	HBLFOAGN
	Red	HBLMOAR	HBLFOAR
	Blue	HBLMOABL	HBLFOABL
	Brown	HBLMOABN	HBLFOABN
	Orange	HBLMOAO	HBLFOAO
	Yellow	HBLMOAY	HBLFOAY

Note: Angled terminals are UL Type 1 only.

Protective Caps



Color	Fits Male Devices	Fits Female Devices
Black	HBLMCAPBK	HBLFCAPBK
White	HBLMCAPW	HBLFCAPW
Green	HBLMCAPGN	HBLFCAPGN
Red	HBLMCAPR	HBLFCAPR
Blue	HBLMCAPBL	HBLFCAPBL
Brown	HBLMCAPBN	HBLFCAPBN
Orange	HBLMCAPO	HBLFCAPO
Yellow	HBLMCAPY	HBLFCAPY

Weather Protective Lift Covers



Color	Catalog Number	All One Color Caps and Bodies
Clear	HBLNCC	—
Black	HBLNCBK	HBLNCABK
White	HBLNCW	HBLNCAW
Green	HBLNCGN	HBLNCAGN
Red	HBLNCR	HBLNCAR
Blue	HBLNCBL	HBLNCABL
Brown	HBLNCBN	HBLNCABN
Orange	HBLNCO	HBLNCAO
Yellow	HBLNCY	HBLNCAY

Single Pole Devices and Temporary Power



Series 16 - 300 and 400 Amp, 600 Volts

Enclosure Types
3R, 4X, 12

Tees and 3-Fers



Color	Paralleling Tee (Male-Male-Female)	Tapping Tee (Female-Male-Female)	3-Fer (Male-Female-Female-Female)	3-Fer (Female-Male-Male-Male)	Soft 3-Fer (Male-Female-Female-Female)	Soft 3-Fer (Female-Male-Male-Male)
Black	HBLPTBK	HBLTBK	HBLM3FBK	HBLF3MBK	HBLM3FSBK	—
White	HBLPTW	HBLTW	HBLM3FW	HBLF3MW	—	—
Green	HBLPTGN	HBLTGN	HBLM3FGN	HBLF3MGN	—	HBLF3MSGN
Red	HBLPTR	HBLTR	HBLM3FR	HBLF3MR	—	—
Blue	HBLPTBL	HBLTBL	HBLM3FBL	HBLF3MBL	—	—
Brown	HBLPTBN	HBLTBN	HBLM3FBN	HBLF3MBN	—	—
Orange	HBLPTO	HBLTO	HBLM3FO	HBLF3MO	—	—
Yellow	HBLPTY	HBLTY	HBLM3FY	HBLF3MY	—	—

Gender Reversing Devices



Color	Double Male (Male-Male)	Double Female (Female-Female)
Black	HBLDMBK	HBLDFBK
White	HBLDMW	HBLDFW
Green	HBLDMGN	HBLDFGN
Red	HBLDMR	HBLDFR
Blue	HBLDMBL	HBLDFBL
Brown	HBLDMBN	HBLDFBN
Orange	HBLDMO	HBLDFO
Yellow	HBLDMY	HBLDFY

Distribution Block



Description	Color	(1-Male, 6-Females)
400 amp Distribution Block, Single Conductor, Heavy Duty Industrial Grade, Pre-Wired, (1) Male to (6) Females.	Black	HBL7DBBK
	White	HBL7DBW
	Green	HBL7DBGN
	Red	HBL7DBR
	Blue	HBL7DBBL
	Brown	HBL7DBBN
Orange	HBL7DBO	
Yellow	HBL7DBY	

Replacement Bodies (10 Pack)



Color	Male Body	Female Body
Black	HBLMBBK	HBLFBBK
White	HBLMBW	HBLFBW
Green	HBLMBGN	HBLFBGN
Red	HBLMBR	HBLFBR
Blue	HBLMBBL	HBLFBBL
Brown	HBLMBBN	HBLFBBN
Orange	HBLMBO	HBLFBO
Yellow	HBLMBY	HBLFBY

Replacement Contacts (20 Pack)



Description	Male Pin	Female Sleeve
Contact, 300 amp	HBL300RCM	HBL300RCF
Contact, 400 amp	HBL400RCM	HBL400RCF

Snap Back Covers (3R Only)



Color	Through Hole Mounting	Threaded Mounting Holes
Black	HBLSCBK	HBLSCCBK
White	HBLSCW	HBLSCCW
Green	HBLSCGN	HBLSCCGN
Red	HBLSCR	HBLSCCR
Blue	HBLSCBL	HBLSCCBL
Brown	HBLSCBN	HBLSCCBN
Orange	HBLSCO	HBLSCCO
Yellow	HBLSCY	HBLSCCY

Accessories



Description	Catalog Number
Accessory Kit, retaining screw, copper foil, terminal screws and brass wire.	HBLPK
Replacement retaining screw (500 pack).	HBLRS
Copper foil (500 pack).	HBLCF
Brass wire (500 pack).	HBLBW
Terminal screw - inline (500 pack).	HBLTS
Terminal screw - panel mount (500 pack).	HBLTSR

Single Pole Devices and Temporary Power

Series 16 - 300 and 400 Amp, 600 Volts

Specifications

Electrical	Series 16	
Voltage Ratings	600V AC Maximum 250V DC Maximum	
Amperage Rating	400A Maximum	
Mechanical	300A	400A
Terminal Accommodation	Inline: #6 to 2/0 AWG	Inline: 2/0 to 4/0 AWG Recept.: #4 to 4/0 AWG
Product ID	Ratings are a permanent part of device	
Base Compound	Thermoplastic Elastomer (TPE)	
Contact Material	Brass	
Retaining Screw Material	Nylon	

Certification / Environmental

UL and cUL Listed
 UL Enclosure Types 3R, 4X, 12
 UL1691 standard for single pole locking-type separable connectors
 National Electric Code (NEC), ANSI/NFPA 70
 Flammability: HB per UL94 or CSA 22.2. 0.17

Conductor Ampacity Chart (Type SC/PPC Wire)

Cable Size	Ampacity*	Cable Size	Ampacity*
#6	105	2/0	300
#4	140	4/0	405
#2	190		

Note: *90°C column NEC Table 400.5(A)(2).

Dimensions

Inlines

Description	A	B	C	D
Male	7.01" (178.0)	1.38" (35.1)	1.48" (37.6)	4.78" (121.4)
Female	7.10" (180.5)	1.44" (36.6)	1.06" (27.0)	4.90" (121.3)

Inline (Male Shown)

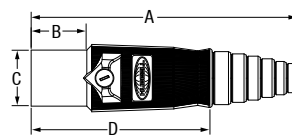

Snap Back Cover

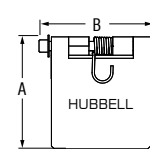

Threaded Stud (Male Shown)

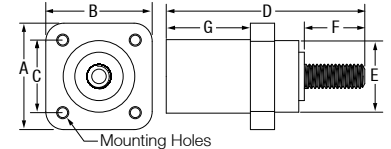

Panel Mount Receptacles

Threaded Stud	A	B	C	D	E	F	G	Mounting Hole	Termination
Male & Female with through hole mounting	2.20" (55.9)	2.20" (55.9)	1.50" (38.1)	4.10" (104.3)	1.48" (47.4)	1.25" (31.7)	1.74" (44.2)	Through 4x Ø .20"	1/2-13 UNC-2A Threaded Stud
Male & Female with threaded mounting holes	2.20" (55.9)	2.20" (55.9)	1.50" (38.1)	3.67" (93.2)	1.48" (47.4)	1.11" (28.2)	1.55" (39.4)	Threaded 4x #10-32	1/2-13 UNC-2A Threaded Stud
Double Set Screw	A	B	C	D	E	F	G	Mounting Hole	Termination
Male & Female with threaded mounting holes	2.20" (55.9)	2.20" (55.9)	1.50" (38.1)	4.10" (104.3)	1.48" (47.4)	1.36" (34.5)	1.74" (44.2)	Threaded 4x #10-32	(2) 7/32 Socket Head Set Screws
Bus Bar Type	A	B	C	D	E	F	G	Mounting Hole	Termination
Male & Female with threaded mounting holes	2.20" (55.9)	2.20" (55.9)	1.50" (38.1)	3.57" (90.7)	1.48" (37.6)	1.01" (25.7)	1.55" (39.4)	Threaded 4x #10-32	(1) 5/16-18 UNC-2B Threaded Hole
Offset Terminals	A	B	C	D	E	F	Mounting Hole	Termination	
Male terminal straight style	Ø1.48" [37.6]	1.00" (25.4)	.38" (9.5)	3.89" (98.8)	1.75" (44.5)	2.14" (54.4)	Through .50" (12.7)	—	
Female terminal straight style	Ø1.48" [37.6]	1.00" (25.4)	.38" (9.5)	3.68" (93.3)	1.75" (44.5)	1.93" (48.9)	Through .50" (12.7)	—	
Male terminal angled style	Ø1.48" [37.6]	1.00" (25.4)	.38" (9.5)	3.98" (101.1)	2.06" (52.2)	2.14" (54.4)	Through .50" (12.7)	—	
Female terminal angled style	Ø1.48" [37.6]	1.00" (25.4)	.38" (9.5)	3.76" (95.6)	2.06" (52.2)	1.93" (48.9)	Through .50" (12.7)	—	

Double Set Screw (Male Shown)

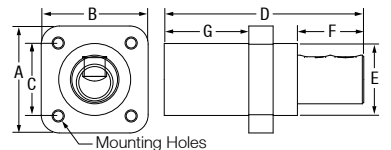

Bus Bar Type (Male Shown)

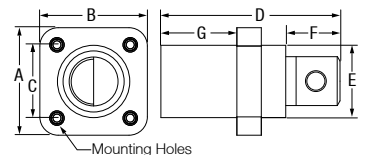

Offset Terminals (Male Shown) Straight Style

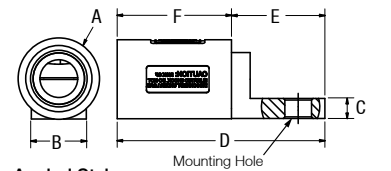

Angled Style

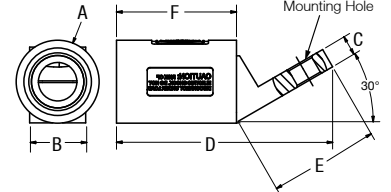

Covers

Description	A	B	C
Weatherproof Cover	2.20" (55.88)	1.16" (29.44)	2.03" (51.5)
Snap Back Cover to be used with receptacles	2.26" (57.4)	2.37" (60.2)	—

Weatherproof Cover

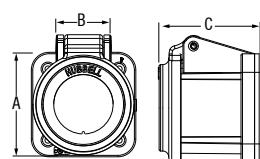

Gender Reversing Devices

Description	A	B	C
Double Male	4.65" (118.1)	1.48" (37.6)	—
Double Female	4.84" (122.9)	1.44" (36.6)	1.06" (27.0)

Gender Reversing - Double Male

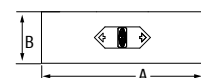

Gender Reversing - Double Female

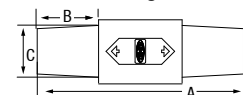

Tees and 3-Fers

Description	A	B	C
Tapping Tee	3.18" (80.8)	4.74" (120.4)	1.48" (37.6)
Paralleling Tee	3.18" (80.8)	4.65" (118.1)	1.48" (37.6)
3-Fer	5.88" (149.3)	5.78" (146.9)	1.48" (37.6)

Tapping Tee

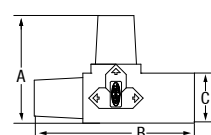

Paralleling Tee

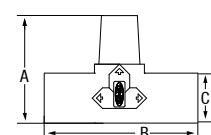

3-Fer

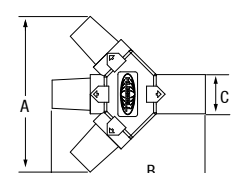

NEC® is a registered trademark of the National Fire Protection Association (NFPA).

Dimensions in Inches (mm)

Single Pole Devices and Temporary Power



Series 18 - 300 and 400 Amp, 600V AC/250V DC

Enclosure Types
3R, 4X, 12

- Enclosure Types 3R, 4X, 12
- Non-metallic safety retaining screw
- Easy to grip body design
- Accepts #2 to 4/0 AWG wire
- Replacement bodies available
- UL and cULus listed



300 Amp Inlines

Description	Color	Male Inline	Female Inline
Thermoplastic elastomer, cable size #2 - 2/0 AWG.	Black	HBL18300MBK	HBL18300FBK
	White	HBL18300MW	HBL18300FW
	Green	HBL18300MGN	HBL18300FGN
	Red	HBL18300MR	HBL18300FR
	Blue	HBL18300MBL	HBL18300FBL
	Brown	HBL18300MBN	HBL18300FBN
	Orange	HBL18300MO	HBL18300FO
	Yellow	HBL18300MY	HBL18300FY

400 Amp Inlines

Description	Color	Male Inline	Female Inline
Thermoplastic elastomer, cable size 3/0 - 4/0 AWG.	Black	HBL18400MBK	HBL18400FBK
	White	HBL18400MW	HBL18400FW
	Green	HBL18400MGN	HBL18400FGN
	Red	HBL18400MR	HBL18400FR
	Blue	HBL18400MBL	HBL18400FBL
	Brown	HBL18400MBN	HBL18400FBN
	Orange	HBL18400MO	HBL18400FO
	Yellow	HBL18400MY	HBL18400FY

Replacement Bodies (10 Pack)



Description	Color	Male Inline	Female Inline
Thermoplastic elastomer.	Black	HBL18MBBK	HBL18FBBK
	White	HBL18MBW	HBL18FBW
	Green	HBL18MBGN	HBL18FBGN
	Red	HBL18MBR	HBL18FBR
	Blue	HBL18MBBL	HBL18FBBL
	Brown	HBL18MBBN	HBL18FBBN
	Orange	HBL18MBO	HBL18FBO
	Yellow	HBL18MBY	HBL18FBY

Accessories

Description	Catalog Number
Series 18, replacement retaining screw (500 pack).	HBL18RS
Copper foil (500 pack).	HBLCF
Brass wire (500 pack).	HBLBW

Specifications

Electrical	Series 18	
Voltage Ratings	600V AC Maximum 250V DC Maximum	
Amperage Rating	400A Maximum	
Mechanical	300A	400A
Terminal Accommodation	Inline: #2 to 2/0 AWG	Inline: 3/0 to 4/0 AWG
Product ID	Ratings are a permanent part of device	
Base Compound	Thermoplastic Elastomer (TPE)	
Contact Material	Brass	
Retaining Screw Material	Nylon	

Certification / Environmental

Series 18
UL and cULus listed
UL Enclosure Types 3R, 4X, 12
UL 1691 standard for single pole locking-type separable connectors
National Electric Code (NEC), ANSI/NFPA 70
Flammability: HB per UL94 or CSA 22.2. 0.17

Conductor Ampacity Chart (Type SC/PPC Wire)

Cable Size	Ampacity*
#2	190
2/0	300
3/0	350
4/0	405

Note: *90°C column NEC Table 400.5(A)(2).

Dimensions

Inlines	A	B	C	D	E	F
Male	6.77" (172.0)	2.06" (52.3)	1.61" (40.9)	1.85" (47.0)	.73" (18.5)	.38" (TYP) (9.7)
Female	6.21" (157.7)	1.50" (38.1)	1.61" (40.9)	1.85" (47.0)	.73" (18.5)	.38" (TYP) (9.7)

Inline (Male)

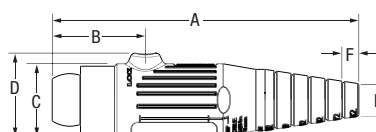

Inline (Female)

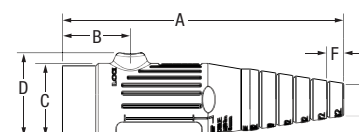

Dimensions in Inches (mm)

Single Pole Devices and Temporary Power

Features and Benefits

Spider® II Temporary Power Boxes

Hubbell's Spider® II temporary power distribution system sets the safety and performance standard for temporary power needs. Construction sites and outdoor events place more demands on electrical power than ever before. Hubbell's Spider box steps up to the challenge by offering advanced electrical and safety features. The Spider II box incorporates the most advanced ground fault module technology available in the industry today, ensuring safe and reliable distribution of electrical power for a wide variety of temporary power applications.

Breadth of line and durability, Hubbell manufactures a variety of Spider® II Boxes and temporary power products for both indoor and outdoor power and lighting applications. Hubbell's Spider products incorporate the most innovative wiring devices in the Hubbell Safety-Shroud® Twist-Lock® system. The shrouded Twist-Lock design extends the life of the plug by protecting the blades from abuse and more importantly, the shroud protects the user from arcing.



SBSB1A



Housing Design

- Individual GFCI modules
- Gasketed latching receptacle lift covers
- Replaceable legs



Receptacles

- Six 20 amp straight blade or Twist-Lock® watertight receptacles, individually GFCI protected
- All Pin and Sleeve, Twist-Lock® and straight blade receptacles on each Spider box are protected when not in use by a gasketed, spring loaded flip lid



Safety

- Standard stab termination circuit breakers with gasketed lift cover
- Compact electronic supervisory circuit
- Detailed wiring diagram



Inlets

- Available with flush 50 amp Twist-Lock® inlet or 60 amp IEC reversed service Pin and Sleeve receptacle



Environmental Protection

- Spider® II boxes have earned a Type 3R metallic enclosure rating and heavy duty, abuse resistant legs for outdoor rainproof applications
- Provides UL Type 4X rating when the receptacles are used with Watertight Safety-Shroud® Twist-Lock® plugs



Certifications

- Hubbell's Spider® II Boxes meet NEC® requirements for personal protection against electrical shock on job sites and are listed to the latest UL1640 standard for portable power distribution equipment

NEC® is a registered trademark of the National Fire Protection Association (NFPA).

Single Pole Devices and Temporary Power

50A and 60A Spider® II Boxes



50A Spider® II



60A Spider® II



60A Class "L" Spider® II

Spider® II Temporary Power Boxes

Rating	Type	Qty	Receptacle Ratings	Receptacle Components	Protection		Catalog Number
					Overload	GFI	
30A, 120/240V AC (Maximum)	Straight Blade	7	20A, 125V	HBL53R61	Yes	Yes	SDSB1A
	Twist-Lock® (inlet)	1	30A, 120/240V	HBL2715SWR	No	No	
	Twist-Lock® (outlet)	1	30A, 120/240V	HBL2710	No	No	
50A, 120/240V AC (Maximum)	Straight Blade	7	20A, 125V	HBL53R61	Yes	Yes	SBSB1A
	Twist-Lock® (inlet)	1	50A, 125/250V	HBL6375S	No	No	
	Twist-Lock® (outlet)	1	50A, 125/250V	CS6369	No	No	
50A, 120/240V AC (Maximum)	Straight Blade	6	20A, 125V	HBL53R61	Yes	Yes	SBSB2
	Twist-Lock®	1	30A, 250V	HBL2620SW	Yes	Yes	
	Twist-Lock® (inlet)	1	50A, 125/250V	HBL6375S	No	No	
	Twist-Lock® (outlet)	1	50A, 125/250V	CS6369	No	No	
50A, 120/240V AC (Maximum)	Twist-Lock®	7	20A, 125V	HBL2310SW	Yes	Yes	SBTL1A
	Twist-Lock® (inlet)	1	50A, 125/250V	HBL6375S	No	No	
	Twist-Lock® (outlet)	1	50A, 125/250V	CS6369	No	No	
50A, 120/240V AC (Maximum)	Twist-Lock®	6	20A, 125V	HBL2310SW	Yes	Yes	SBTL2
	Twist-Lock®	1	30A, 250V	HBL2620SW	Yes	Yes	
	Twist-Lock® (inlet)	1	50A, 125/250V	HBL6375S	No	No	
	Twist-Lock® (outlet)	1	50A, 125/250V	CS6369	No	No	
60A, 3Ø 120/208V AC (Maximum)	Straight Blade	6	20A, 125V	HBL53R61	Yes	Yes	SCSB0*
	Pin and Sleeve (inlet)	1	60A, 3ØY 120/208V	HBL560B9R	No	No	
	Pin and Sleeve (outlet)	1	60A, 3ØY 120/208V	HBL560R9W	No	No	
60A, 3Ø 120/208V AC (Maximum)	Twist-Lock®	6	20A, 125V	HBL2310SW	Yes	Yes	SCTL0*
	Pin and Sleeve (inlet)	1	60A, 3ØY 120/208V	HBL560B9R	No	No	
	Pin and Sleeve (outlet)	1	60A, 3ØY 120/208V	HBL560R9W	No	No	

Class "L" Spider® II Temporary Power Boxes

Rating	Type	Qty	Receptacle Ratings	Receptacle Components	Protection		Catalog Number
					Overload	GFI	
60A, 3Ø 120/208V AC (Maximum)	Straight Blade	6	20A, 125V	HBL53R61	Yes	Yes**	SCSB0M2
	Class "L" (inlet)	1	60A, 3ØY, 120/208V	—	No	No	
	Class "L" (outlet)	1	60A, 3ØY, 120/208V	—	No	No	
60A, 3Ø 120/208V AC (Maximum)	Twist-Lock®	6	20A, 125V	HBL2310SW	Yes	Yes**	SCTL0M2
	Class "L" (inlet)	1	60A, 3ØY, 120/208V	—	No	No	
	Class "L" (outlet)	1	60A, 3ØY, 120/208V	—	No	No	

Note: *60A units are UL and cUL only.
**GFCI protection on 4 devices only.

Dimensions

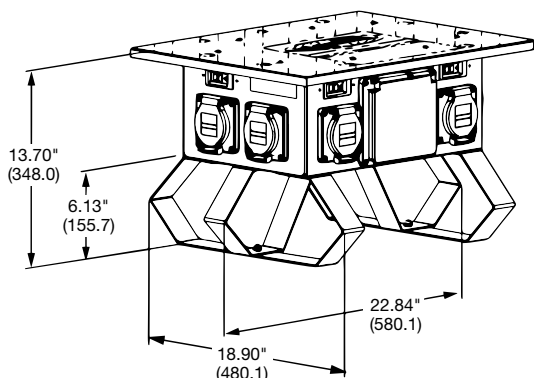

Dimensions in Inches (mm)

Specifications

Spider® II

Listing/Certification	UL1640 cUL and CSA, UL943
Environment	Indoor and outdoor wet and dry locations
Enclosure Type	3R, rainproof, suitable for use in damp locations
Code Compliance	NEC®, ANSI/NFPA 70

NEC® is a registered trademark of the National Fire Protection Association (NFPA).

Single Pole Devices and Temporary Power

Features and Benefits

Temporary Power Accessories

Hubbell's SR50 is comprised of a pre-wired 50A receptacle, mounted in a fully non-metallic watertight FD wall box.

This weather resistant, UL listed, assembly provides significant labor savings for the contractor, because it's pre-wired with a 50A Twist-Lock® receptacle, installation time is significantly reduced. The 4 hole mounting pattern of the new FD box also provides added security for the device.



Cable Sets and Receptacles

Description	Catalog Number
50A pre-wired wall mounted receptacle, with 2 ft. wire leads.	SR50
50A cord set - 50 ft. cable (input/output).	SCB50
50A cord set - 100 ft. cable (input/output).	SCB100
60A cord set - 6 ft. cable (input/output).	SCC06
60A cord set - 50 ft. cable (input/output).	SCC50
60A, 3Ø 120/208V Pin and Sleeve wall mounted receptacle.	HBL560R9W
1¼" hub 15 deg. non-metallic angle back box for 60A receptacle.	BB601W
1½" hub 15 deg. metallic 4-way angle back box for 60A receptacle.	FW60100

Note: Consult factory for alternate cable lengths.



SR50

Replacement Parts

Description	Catalog Number
20A, 125V straight blade receptacle.	HBL53R61
20A, 125V Safety-Shroud Twist-Lock® receptacle.	HBL2310SW
30A, 250V Safety-Shroud Twist-Lock® receptacle.	HBL2620SW
30A, 125/250V Reverse Service Safety-Shroud connector.	HBL2713SR
30A, 125/250V Reverse Service inlet.	HBL2715SWR
50A, 125/250V Twist-Lock® receptacle.	CS6369
50A, 125/250V Twist-Lock® inlet.	HBL6375S
60A, 3Ø 120/208V Pin and Sleeve reversed service receptacle (inlet).	HBL560B9R
60A, 3Ø 120/208V Pin and Sleeve receptacle (outlet).	HBL560R9W
60A, 3Ø 120/208V Pin and Sleeve reversed service plug (female).	HBL560P9WR
60A, 3Ø 120/208V Pin and Sleeve plug (male).	HBL560P9W
GFCI module.	GFM20
50A Spider supervisory kit.	SSK
60A Spider supervisory kit.	SSK60
Spider circuit breaker cover.	SCBC
Spider leg kit.	SLK
Spider leg kit, green.	SLKG
50A receptacle cover plate.	HBL77CM74WO



SCB50



HBL560R9W



HBL2713SR



SCBC



GFM20



SSK



HBL77CM74WO



CS6369



HBL2310SW

Single Pole Devices and Temporary Power

Features and Benefits

Temporary Power Distribution Boxes and Temporary Power Cables

- Durable hi-visibility yellow powder coated steel construction
- Hubbell 50 amp Twist-Lock® receptacle and inlet
- Six 20 amp straight blade or Twist-Lock® covered receptacles
- Individual GFCI modules
- NEMA 3R enclosure
- Nesting leg design saves space in the warehouse and on the truck



TPDL – Twist-Lock®
TPDS – Straight Blade



TPC50 – 50' Cable
TPC100 – 100' Cable



HBLCGFM20

Temporary Power Distribution Boxes

Rating	Type	Qty	Receptacle Rating	Protection		Catalog Number
				Overload	GFI	
50A, 120/240V AC (Maximum)	Twist-Lock®	6	20A, 125V	Yes	Yes	TPDL
	Twist-Lock®	1	30A, 250V	Yes	No	
	Twist-Lock® (Inlet)	1	50A, 125/250V	No	No	
	Twist-Lock® (Outlet)	1	50A, 125/250V	No	No	
50A, 120/240V AC (Maximum)	Straight Blade	6	20A, 125V	Yes	Yes	TPDS
	Twist-Lock®	1	30A, 250V	Yes	No	
	Twist-Lock® (Inlet)	1	50A, 125/250V	No	No	
	Twist-Lock® (Outlet)	1	50A, 125/250V	No	No	
Replacement GFCI module.						HBLCGFM20

Temporary Power Cables

Rating	CableType	Length	Male Device	Female Device	Weatherproof	Catalog Number
					Boot	
50A, 125/250V	6/3, 8/1	50 ft.	CS6365L	CS6364L	No	TPC50
50A, 125/250V	6/3, 8/1	100 ft.	CS6365L	CS6364L	No	TPC100

Specifications

Boxes	
Listings/Certifications	UL1640, UL943
Operation	Indoor and outdoor wet and dry locations
Enclosure Type	3R, rainproof, suitable for use in damp locations
Code Compliance	NEC®, ANSI/NFPA 70

Cables	
Listings/Certifications	Connectors: UL/CSA; Cable: MSHA
Operation	Indoor and outdoor wet and dry locations

Dimensions

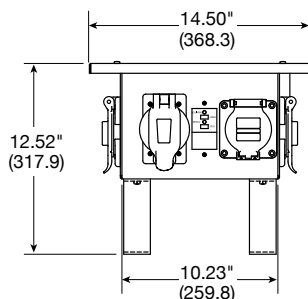

Dimensions in Inches (mm)

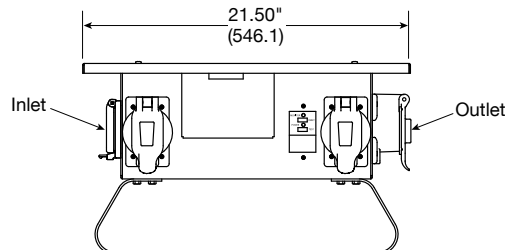

NEC® is a registered trademark of the National Fire Protection Association (NFPA).

Heavy-Duty Portable Outlet Boxes and Cover Plates

Description	Catalog Number
Box with cord strain relief, with one blank cover plate.	HBLPOB1
Box with cord strain relief, with one blank cover plate, black.	HBLPOB1BK
Box with cord strain relief, with two duplex (indoor) cover plates.	HBLPOB1D
Box with cord strain relief, with two duplex (indoor), yellow cover plates.	HBLPOB1DY
Blank, non-metallic FS cover plate with foam gasket, gray.	HBLP14FS
Duplex, non-metallic FS cover plate, gray.	HBLP8FS
Duplex, non-metallic FS cover plate, yellow.	HBLP8FSY
Single receptacle (1.39"), non-metallic FS cover plate, gray.	HBLP7FS
Single receptacle (1.56"), non-metallic FS cover plate, gray.	HBLP720FS
Rectangular opening, non-metallic FS cover plate, gray.	HBLP26FS



HBLPOB1

Other Cover Plates and Devices

which may be used with Heavy-Duty Portable Outlet Boxes

Description	Catalog Number
Duplex cover plate, weatherproof.	HBL5221, HBL52CM21
Single receptacle (1.39") cover plate, weatherproof.	HBL7423WO, HBL74CM23WO
Single receptacle (1.56") cover plate, weatherproof.	HBL7425WOA, HBL74CM25WOA
Safety-Shroud Twist-Lock® surface receptacles.	HBL2310SR, HBL2320SR, HBL2330SR, HBL2610SR, HBL2620SR



Cover Plates

Note: Standard product gray, CM yellow.

Deluxe Cord Grips Straight Male Thread Nylon Fittings, Stainless Steel Mesh, Liquidtight, for Insulated Cables

Grip Diameter Range Inches (mm)	Thread Size NPT (inches)	Form Size	Catalog Number
.375"-.500" (9.5-12.7)	3/4"	F3	074011335
.500"-.625" (12.7-15.9)	3/4"	F3	074011336
.625"-.750" (15.9-19.0)	3/4"	F3	074011337

Gray Nylon Cord Connector Straight Male Thread

Grip Diameter Range Inches (mm)	Thread Size NPT (inches)	Form Size	Catalog Number
.375"-.500" (9.5-12.7)	3/4"	F3	SHC1035CR
.500"-.625" (12.7-15.9)	3/4"	F3	SHC1036CR
.625"-.750" (15.9-19.0)	3/4"	F3	SHC1037CR



**Deluxe Cord Grips
(purchased separately)**

Specifications for Heavy-Duty Portable Outlet Boxes and Cover Plates

UL Listed	UL514C, UL467 and UL50 Enclosures Types 1, 3R.
CSA Certified	C22.2 No. 18 and C22.2 No. 94 Enclosures Types 1, 3R and C22.2 No. 0.4 (Impedance).
Box Specifications:	
Moisture Resistance	Wet and damp locations, enclosure Type 3R when used with weatherproof cover plates; Dry, indoors locations, enclosure Type 1 with all other cover plates
Flammability	UL94V-0, 94-5VA classification
Operating Temperature	80°C maximum; -35°C minimum
UV Resistance	All materials are UV stabilized
Impact and Crush Resistance	In accordance with UL514C, UL50, C22.2 No. 18 and C22.2 No. 94
Material	Valox®
Cord Connector Materials	Nylon nut; nylon Gotcha® ring; neoprene grommet
Cord Diameter Range	.38" to .75" diameter
Bonding Strap Material	Brass
Threaded Inserts	Brass
Grounding Screw Material	Brass
Indoor Cover Plate Screws Material	Zinc plated steel
Outdoor Cover Plate Screws Material	Stainless steel
Cover Plate Gasket Material	UL recognized closed-cell foam (aging and oil resistant)



**Gray Nylon
Cord Connector**

Dimensions

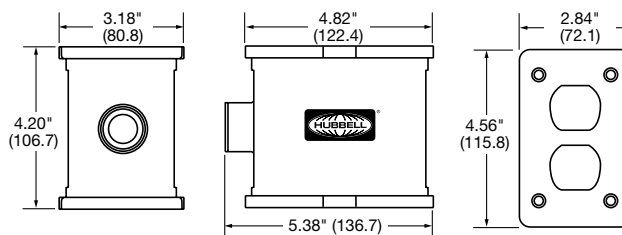

HBLPOB1

Valox® is a trademark of SABIC Innovative Plastics, acquired from General Electric Company.

Dimensions in Inches (mm)

Single Pole Devices and Temporary Power

Construction Site Lighting

Hubbell's outdoor approved construction site lighting line includes both heavy duty metal halide lights and light strings for working in rugged environments. The metal halide fixtures feature extremely strong and compact heads with bulbs rated to last 10,000 hours. All frames are powder-coated yellow for safety and are constructed of a durable 1.25 inch, 12 gauge steel tube.

We have light strings for all applications in a variety of models as well as a choice of metal or plastic guards. Light sockets are spaced 10 feet apart and all sockets, plugs, and connectors are molded for added durability. In addition, the highly impact-resistant material makes for easy transportation and storage when not in use. Bulbs can be incandescent, fluorescent or LED. Consider choosing LED lighting for a durable bulb that saves energy, provides instant illumination and are rated to last 50,000 hours.



HBLMH1000



HBLMH400



HBLLEDH120



HBL182S50LEDH



HBL143SJ100PS



HBLFS2549
Straps not Shown

Metal Halide and LED Lights

Description	Rating	Watts	Lumen Output	Cord Length	Catalog Number
5 -10 ft. metal halide cart light with portable detachable ballast.	15A 125V	1,000	110,000	—	HBLMH1000
6 -12 ft. metal halide cart light.	15A 125V	2,000	220,000	—	HBLMH2000
High bay metal halide light with wire guard.	15A 125V	400	29,000	3 ft.	HBLMH400
High bay LED light with wire guard.	15A 125V	120	14,000	5 ft.	HBLLEDH120

LED Stringer Lights

Description	No. of Fixtures	Rating	Cord Type	Lumen Output	Cord Length	Catalog Number
90 LEDs per fixture, light string with magnetic base included.	1	15A 125V	#18/2 SJTW	450*	20 ft.	HBL182S20LED
90 LEDs per fixture, light string.	5	15A 125V	#18/2 SJTW	450*	50 ft.	HBL182S50LED
	10	15A 125V	#18/2 SJTW	450*	100 ft.	HBL182S100LED
60 LEDs per fixture, light string with magnetic base included.	1	15A 125V	#18/2 SJTW	1,100*	20 ft.	HBL182S20LEDH
	5	15A 125V	#18/2 SJTW	1,100*	50 ft.	HBL182S50LEDH
28W High power LED light string with inline ON/OFF switch.	—	15A 125V	#16 AWG SJTOW	2,928	6 ft.	HBLLS2834
Magnetic clip bracket for LED.	—	—	—	—	—	HBLSTMC

Note: *Lumens per fixture.

A Type (Edison) Twist-Lock® and Straight Blade Light Strings

Description	Max Watts**	Rating	Cord Type	Fixtures	Cord Length	Catalog Number
Twist-Lock® light string; plastic guards.	150	20A 125V	#12/3 STW	10	100 ft.	HBL123S100PT
	150	20A 125V	#12/3 STJW	10	100 ft.	HBL123SJ100PT
Twist-Lock® light string; metal guards.	150	20A 125V	#12/3 STW	10	100 ft.	HBL123S100MT
Straight Blade light string; plastic guards.	150	15A 125V	#14/2 STJW	10	100 ft.	HBL142SJ100PS
	150	15A 125V	#14/3 STJW	10	100 ft.	HBL143SJ100PS
	150	15A 125V	#12/3 STW	10	100 ft.	HBL123S100PS
	150	15A 125V	#12/3 STJW	10	100 ft.	HBL123SJ100PS
	150	15A 125V	#12/3 STW	10	100 ft.	HBL123S100MS
Straight Blade light string; metal guards.	150	15A 125V	#12/3 STW	5	50 ft.	HBL123S50PS
Straight Blade light string; plastic guards.	150	15A 125V	#12/3 STW	5	50 ft.	HBL123S50MS
Straight Blade light string; metal guards.	150	15A 125V	#12/3 STW	5	50 ft.	HBL123S50MS
Replacement plastic guard for temporary light strings.	—	—	—	—	—	HBLSTPG
Replacement heavy duty metal guard for temporary light strings.	—	—	—	—	—	HBLSTMG

Note: **Max watts per fixture. **HBL143SJ100PS** light strings are rated for 1875 Watts total. The total wattage must be considered when daisy chaining lights strings to each other.

Fluorescent Light Strings

Description	Wattage	Rating	Cord Type	Lumen Output	Cord Length	Catalog Number
Fluorescent light string, 34.5" single fixture with hanging straps	50	15A 125V	#16 AWG SJTOW	3,750	6 ft.	HBLFS5035
Fluorescent light string, 48.5" single fixture with hanging straps	25	15A 125V	#16 AWG SJTOW	2,125	6 ft.	HBLFS2549

Single Pole Devices and Temporary Power

LED Maintenance Worklights

Description	Outlet Rating	Rating	Wattage	Lumen Output	Cord Type	Cord Length	Catalog Number
LED Industrial maintenance light, 1 vertical hanging hook included.	N/A	15A 125V	20	2400	#16/3 SJEOW	25 ft.	HBLML2825L
LED worklight with end light feature.	N/A	15A 125V	9	920/120	#18/2 SJTOW	25 ft.	HBLWL25LED
LED worklight with end light feature and tool tap.	12 Amp	15A 125V	9	920/120	#16/3 SJTOW	25 ft.	HBLWL25LEDT



Fluorescent Maintenance Worklights

Description	Outlet Rating	Rating	Wattage	Lumen Output	Cord Type	Cord Length	Catalog Number
Fluorescent worklight with straight blade plug.	N/A	15A 125V	13	825	#16/3 SJTOW	25 ft.	TW25F1
Fluorescent worklight with Twist-Lock® plug and tool tap.	12 Amp	20A 125V	13	825	#16/3 SJTOW	25 ft.	TW25F2
Fluorescent maintenance light, 34.5 in., one vertical hanging hook included.	N/A	15A 125V	50	3750	#16/3 SJEOW	25 ft.	HBLML5025
Fluorescent maintenance light, 48.5 in.	N/A	15A 125V	25	2125	#16/3 SJEOW	25 ft.	HBLML2525
Fluorescent worklight, 45 in., 2 horizontal plastic hangers, 1 attached metal hanging hook included.	N/A	15A 125V	25	2125	#16/3 SJTOW	25 ft.	HBLWL2525



Accessories and Replacement Items

Description	Catalog Number
Magnetic mounting bracket for ML style lights, 82 lb. capacity.	HBLMLMM
Magnetic mounting bracket for WL style lights, 58 lb. capacity.	HBLWLMM
Replacement rough service fluorescent bulb for 13 watt style lamps.	HBLREPPFB
Metal halide replacement bulb, 400 watts.	HBLREP400MH
Metal halide replacement bulb, 1,000 watts.	HBLREP1000MH
Replacement LED panel fixture, 90 LEDs, 450 lumen.	HBLREP450LED
5 base LED string only, 50 ft., 18/2.	HBLREP182S50
10 base LED string only, 100 ft., 18/2.	HBLREP182S100



HBLMLMM



HBLWLMM



HBLREPPFB



HBLREP400MH



HBLREP1000MH

Explosion Proof/Confined Space Lighting

Hazardous Location Lights

Description	Wattage	Lumen Output	Cord Type	Cord Length	Catalog Number
Fluorescent, Class 1, Div 1 Groups C & D, Class 2, Div 1 Groups F & G, 12V, inline transformer.	26	1800	#16/3 SOW	60 ft.	HBLXF6012V
Incandescent, Class 1, Div 1, Groups C & D, 12V, inline transformer.	75	720	#16/3 SOW	60 ft.	HBLXI6012V
Fluorescent, Class 1, Div 1 Groups C & D, Class 2, Div 1 Groups F & G, 120V, less plug.	26	1800	#16/3 SOW	50 ft.	HBLXF50120V
Incandescent, Class 1, Div 1 Groups C & D, 120V less plug.	100	1230	#16/3 SOW	50 ft.	HBLXI50120V
Fluorescent, non-explosion proof, wet location, 12V, inline transformer.	13	825	#18/2 SJTOW	60 ft.	HBLWT6012V



Single Pole Devices and Temporary Power

Pre-Wired Portable Outlet Boxes, Worklights and Accessories



SPB1

Pre-Wired Portable Outlet Boxes

Description	Catalog Number
25 ft. with 2-15A, 125V, straight blade single receptacles and 1-15A, 125V straight blade plug and boot.	SPB1
25 ft. with 2-20A, 125V, Twist-Lock® single receptacles and 1-20A, 125V Twist-Lock® plug and boot.	SPB2



SPB2

Worklights and Accessories

Description	Catalog Number
Temporary low voltage worklight with cigarette lighter plug, 20 ft. cord.	TWLV20F
Non-metallic temporary worklight hook.	TWH

Specifications

Temporary Worklights

Listing/Certification	UL298 and cUL portable electric hand lamps
Environment	Dry, indoor locations
Fluorescent Lamp	13 watt twin tube only

Battery Pack and Charger

Environment	Indoor and outdoor dry locations
Fluorescent Lamp Life	Fully charged-5 hour approx
Charge Time	Fully charged-16 hours approx
Battery Rating	12 volt



TWLV20F



TWH

Light Fixture

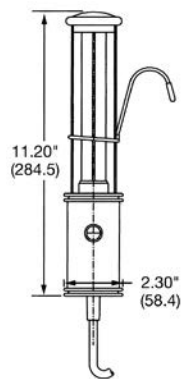

Worklight Hook

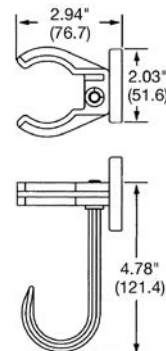

Dimensions in Inches (mm)